

# DIODE MODULE 50A/800V

# PT50S8

## FEATURES

- \* Isolated Base
- \* 3 Phase Bridge Circuit
- \* Designed Power Circuit Board
- \* High Surge Capability
- \* UL Recognized, File No. E187184

## TYPICAL APPLICATIONS

- \* Rectified For General Use

## OUTLINE DRAWING

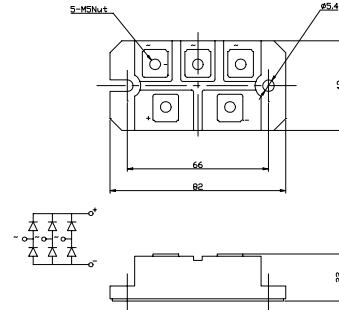

## Maximum Ratings

Approx Net Weight:180g

Parameter	Symbol	Type / Grade	Unit
		PT50S8	
Repetitive Peak Reverse Voltage *1	$V_{RRM}$	800	V
Non Repetitive Peak Reverse Voltage *1	$V_{RSM}$	1000	

Parameter		Conditions	Max Rated Value	Unit
Average Rectified Output Current	$I_{O(AV)}$	3-Phase Full Wave Rectified $T_c = T_t(\text{Terminal}) = 111^\circ\text{C}$	50	A
Surge Forward Current *1	$I_{FSM}$	50 Hz Half Sine Wave, 1Pulse Non-repetitive	450	A
I Squared t *1	$I^2t$	2msec to 10msec	1000	A <sup>2</sup> s
Operating Junction Temperature Range	$T_{jw}$		-40 to +150	°C
Storage Temperature Range	$T_{stg}$		-40 to +125	°C
Isolation Voltage	Viso	Base Plate to Terminals, AC1min	2000	V
Mounting torque	Case mounting	Greased	2.4 to 2.8	N.m
	Terminals	M5 Screw		
	$F_{tor}$	M5	2.4 to 2.8	

## Electrical • Thermal Characteristics

Characteristics	Symbol	Test Conditions	Max.	Unit
Peak Reverse Current *1	$I_{RM}$	$V_{RM} = V_{RRM}$ , $T_j = 150^\circ\text{C}$	10	mA
Peak Forward Voltage *1	$V_{FM}$	$I_{FM} = 50\text{A}$ , $T_j = 25^\circ\text{C}$	1.2	V
Thermal Resistance	$R_{th(j-c)}$	Junction to Case (Total)	0.35	°C/W
	$R_{th(c-f)}$	Base Plate to Heat Sink with Thermal Compound (Total)	0.06	

\*1: Value Per 1Arm

PT50S8 OUTLINE DRAWING (Dimensions in mm)

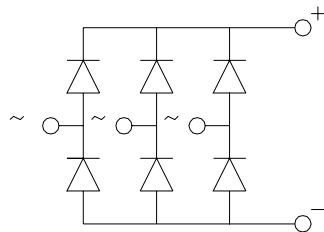
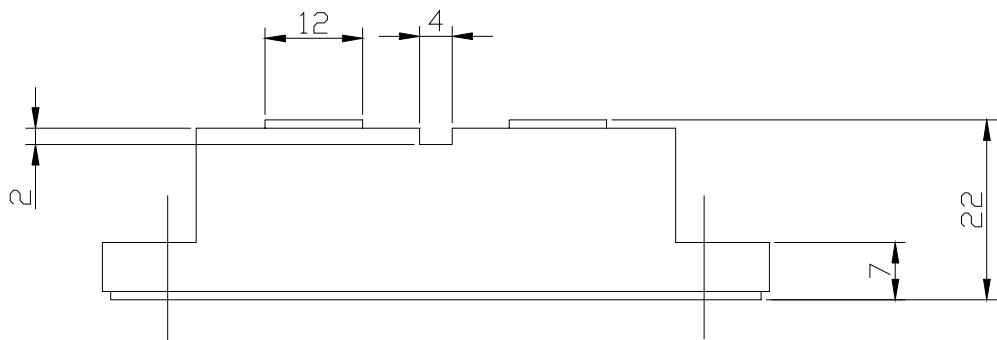
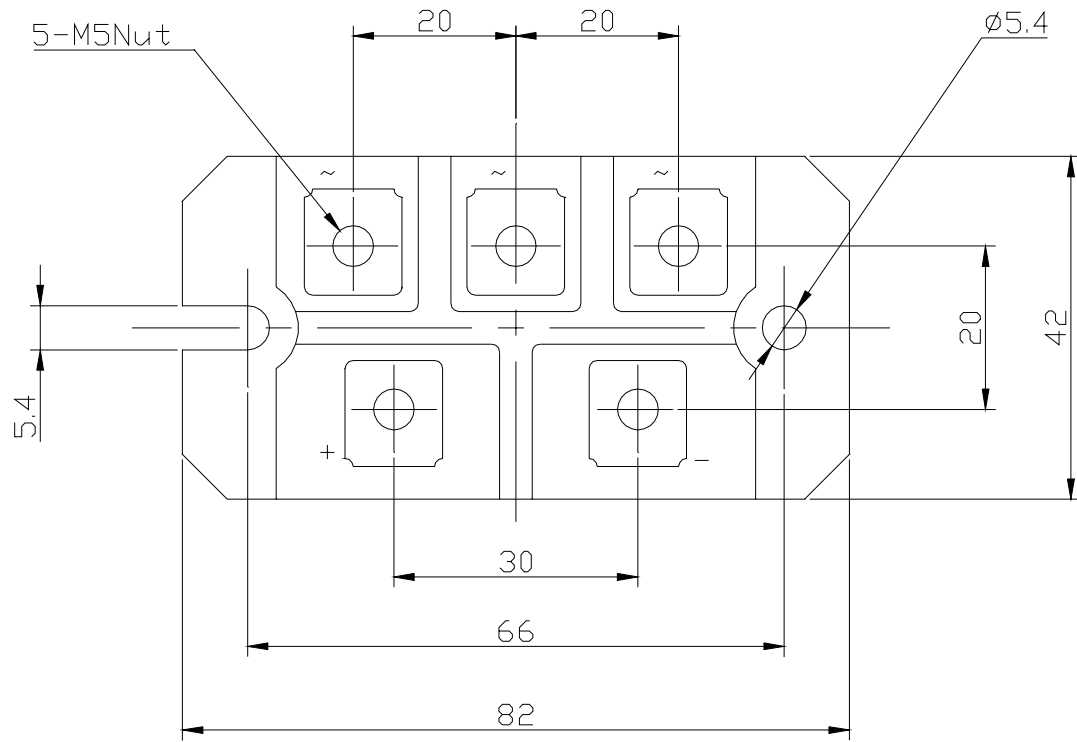

# FORWARD CURRENT VS. VOLTAGE

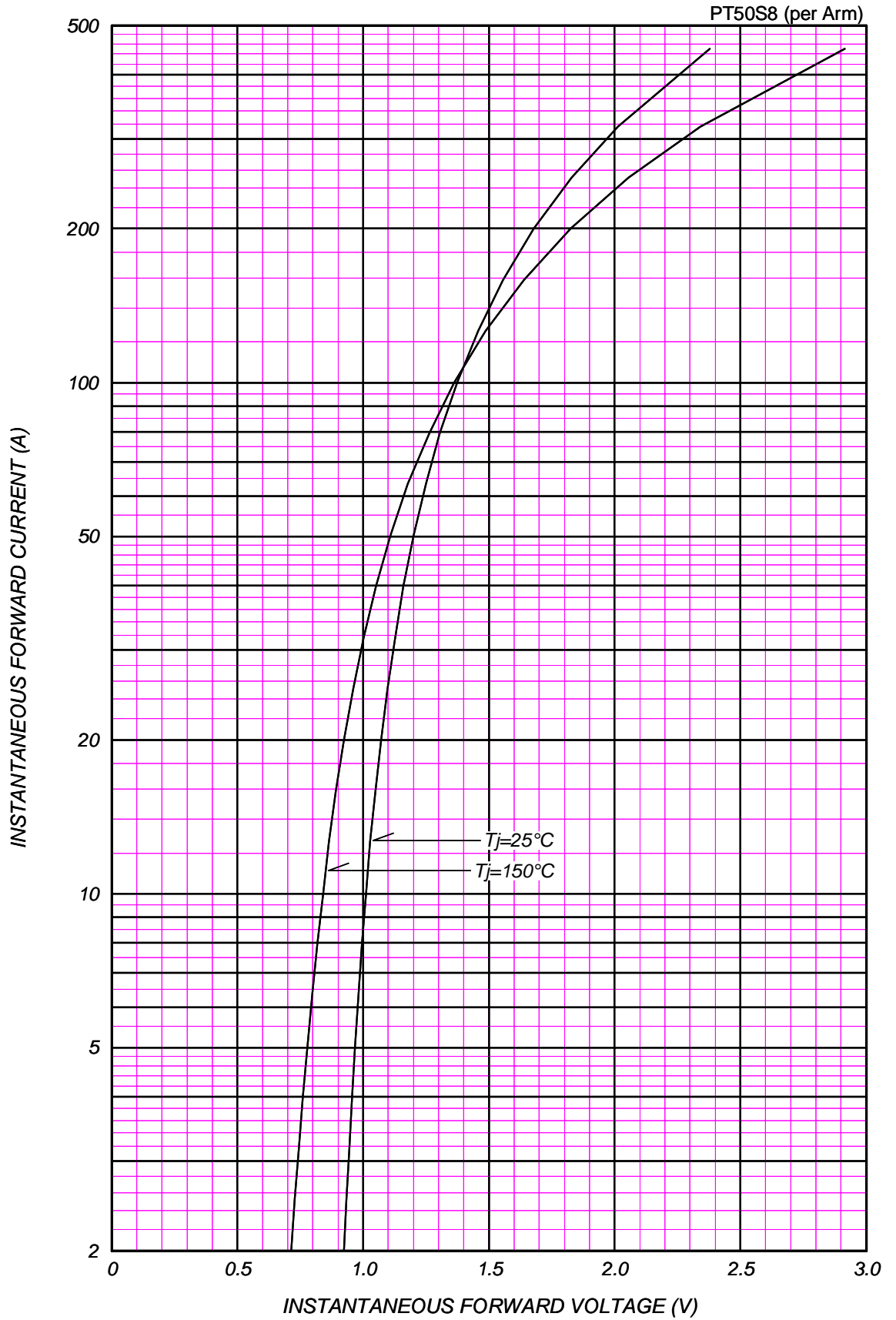

### AVERAGE FORWARD POWER DISSIPATION

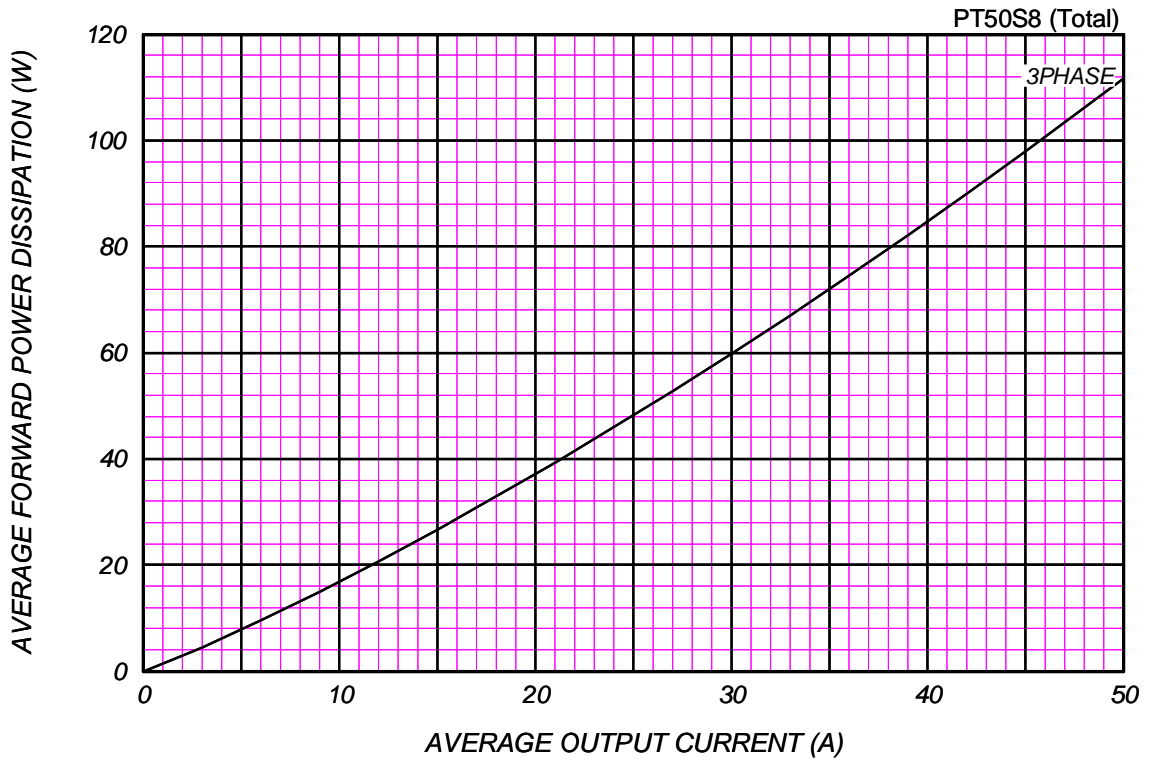

### AVERAGE OUTPUT CURRENT VS. CASE TEMPERATURE

3-Phase Full Wave, Resistive or Inductive Load

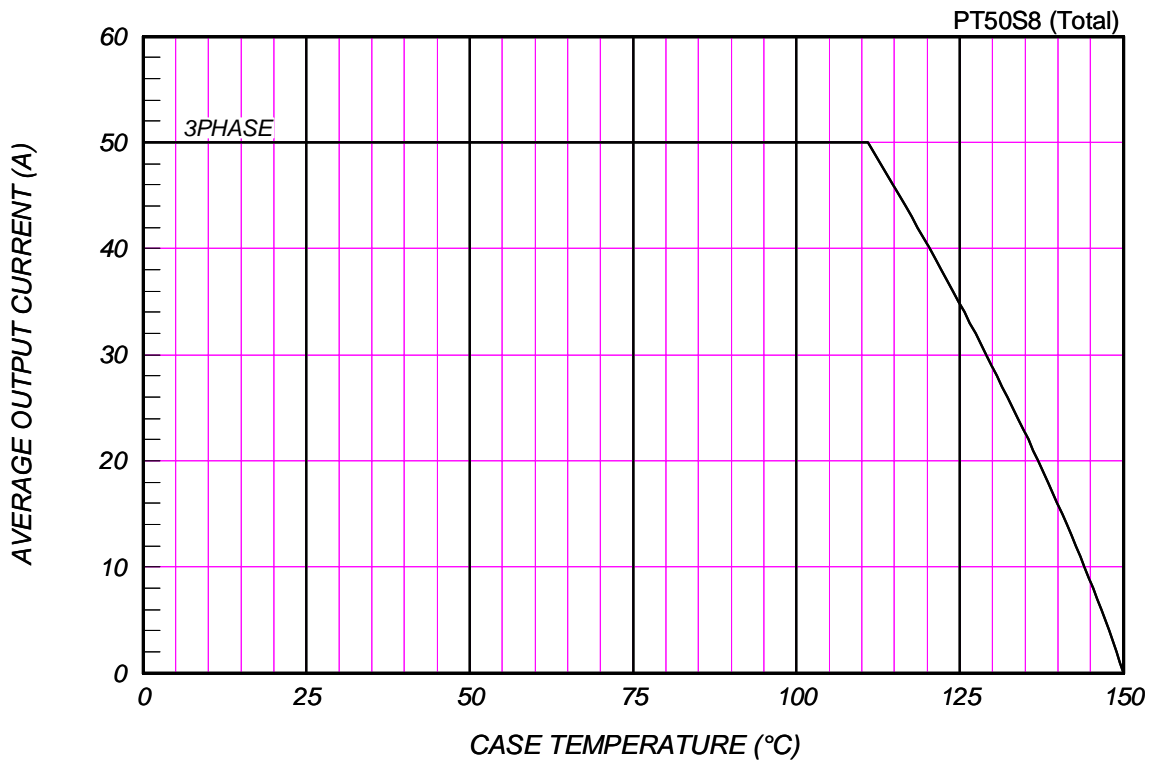

### SURGE CURRENT RATINGS

f=50Hz,Half Sine Wave,Non-Repetitive,T<sub>j</sub>=150°C

PT50S8

